

**Manual for Q1x00N Nano Motherboard v2.0**

**Catalogue**

I、 Product Description ..... 2

    1. Brief Introduction ..... 2

    2. Version Specification..... 2

    3. Characteristics & Performances..... 2

II、 Product Overview ..... 3

    1. Front View ..... 3

    2. Back View ..... 3

    3. Connectors and Headers ..... 4

III、 Detailed Description of Connection Ports ..... 6

    1. Power Input Port ..... 6

    2. HDMI Connector ..... 6

    3. VGA Connector ..... 6

    4. 1000M LAN Port..... 6

    5. 4 \* USB 2.0 Ports ..... 6

    6. Audi Output Port..... 6

    7. SATA 3.0 Port (6.0 Gb/s) ..... 6

    8. SATA Power Connector ..... 7

    9. PCI Express Half-Mini Card Slot (For WIFI and Bluetooth ) ..... 7

    10. PCI Express Full-Mini Card Slot (For MSATA SSD) ..... 7

    11. Intel Celeron J1800/J1900 Processor..... 7

    12. USB 3.0 Port..... 7

    13. Serial Port ..... 8

    14. Power Switch..... 8

    15. Microphone Input ..... 8

    16. Extended Audio Input and Output Pin..... 8

    17. Serial port headers (optional)..... 8

    18. Serial port headers (optional)..... 9

    19. Serial port headers (optional)..... 9

    20. Extended USB Pin ..... 9

    21. System Fan Header ..... 9

    22. VGA Connection Pin ..... 9

    23. Power led ..... 10

    24. Extended Pin for External Panel ..... 10

25. Debug Pin LPC1 ..... 10  
 26. DC in header ..... 11  
 27. Battery Slot ..... 11  
 28. Memory Slot ..... 11

## I、Product Description

### 1. Brief Introduction

Q1x00NP is a Standard Ultrathin Nano Mini-ITX motherboard designed based on the Intel Baytrail Platform, with the size of 120mm x120mm. It adopts onboard Intel Celeron J1800/J1900 CPU.

### 2. Version Specification

Version NO.	Motherboard NO.	QTY of Network Card	QTY of USB Ports
<b>V2.0</b>	Q1X00N	<b>1</b>	<b>5</b>

### 3. Characteristics & Performances

#### 1) Great reliability

With the adoption of the J1800/J1900 ultra power consumption processor and switching mode power supply, Q1x00N motherboard can provide stable, sufficient and efficient power. The stability of the motherboard is further guaranteed with the switching mode of power supply applied in memory, too. All of the external devices of the motherboard is composed of some anti-static and jam-proof components which ensured the operation of a stable and efficient system.

#### 2) High Performance

It considerably increases performance of the platform by employing the Baytrail chipset of Intel and SATA3.0

#### 3) Full Support of BIOS

Support Diskless booting and Wake on LAN

#### 4) Working Condition

Working Temperature : -10°C ~ 50°C

Working Humidity : 5% ~ 95% ( Non-gel )

## II、 Product Overview

### 1. Front View

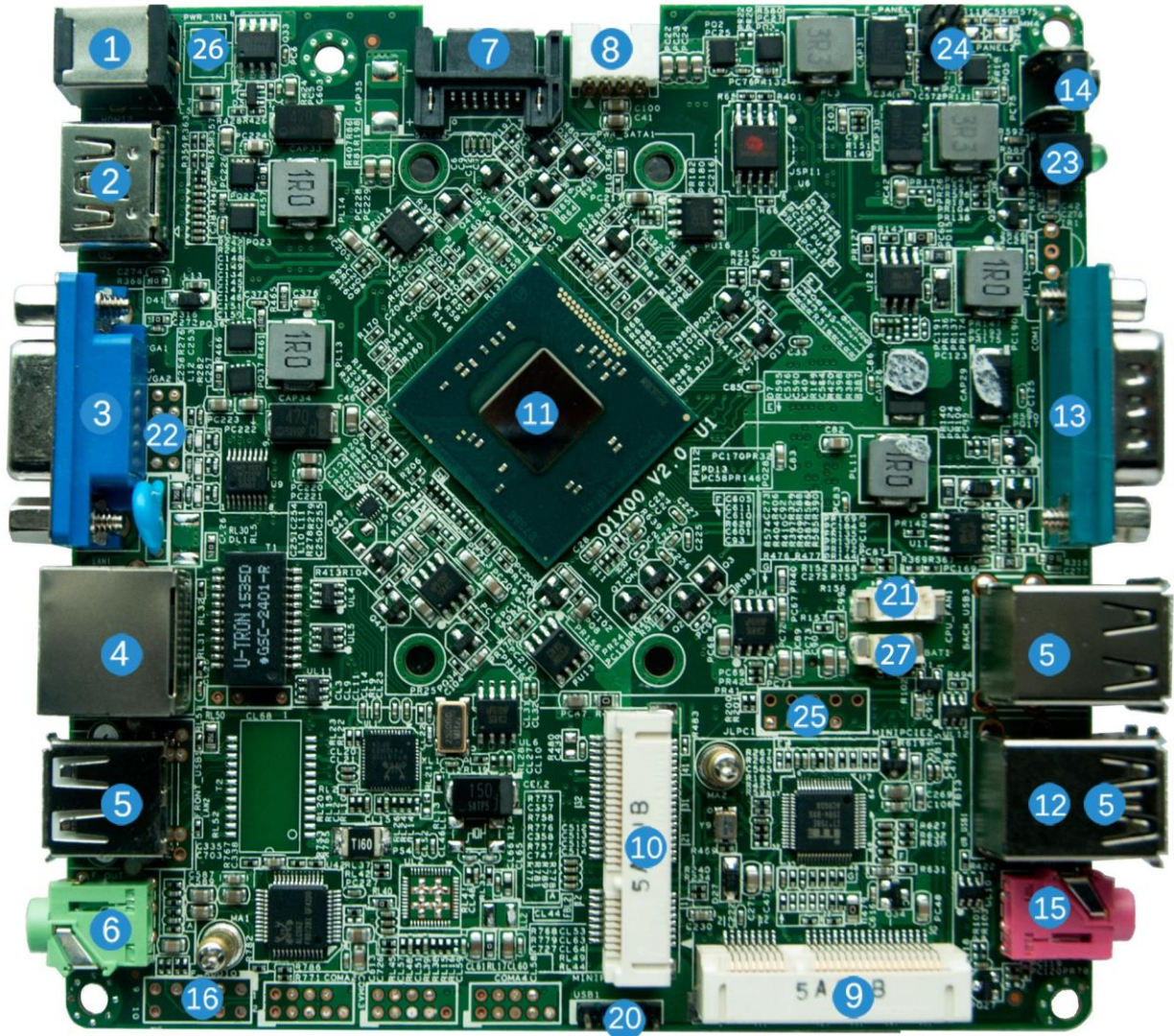

### 2. Back View

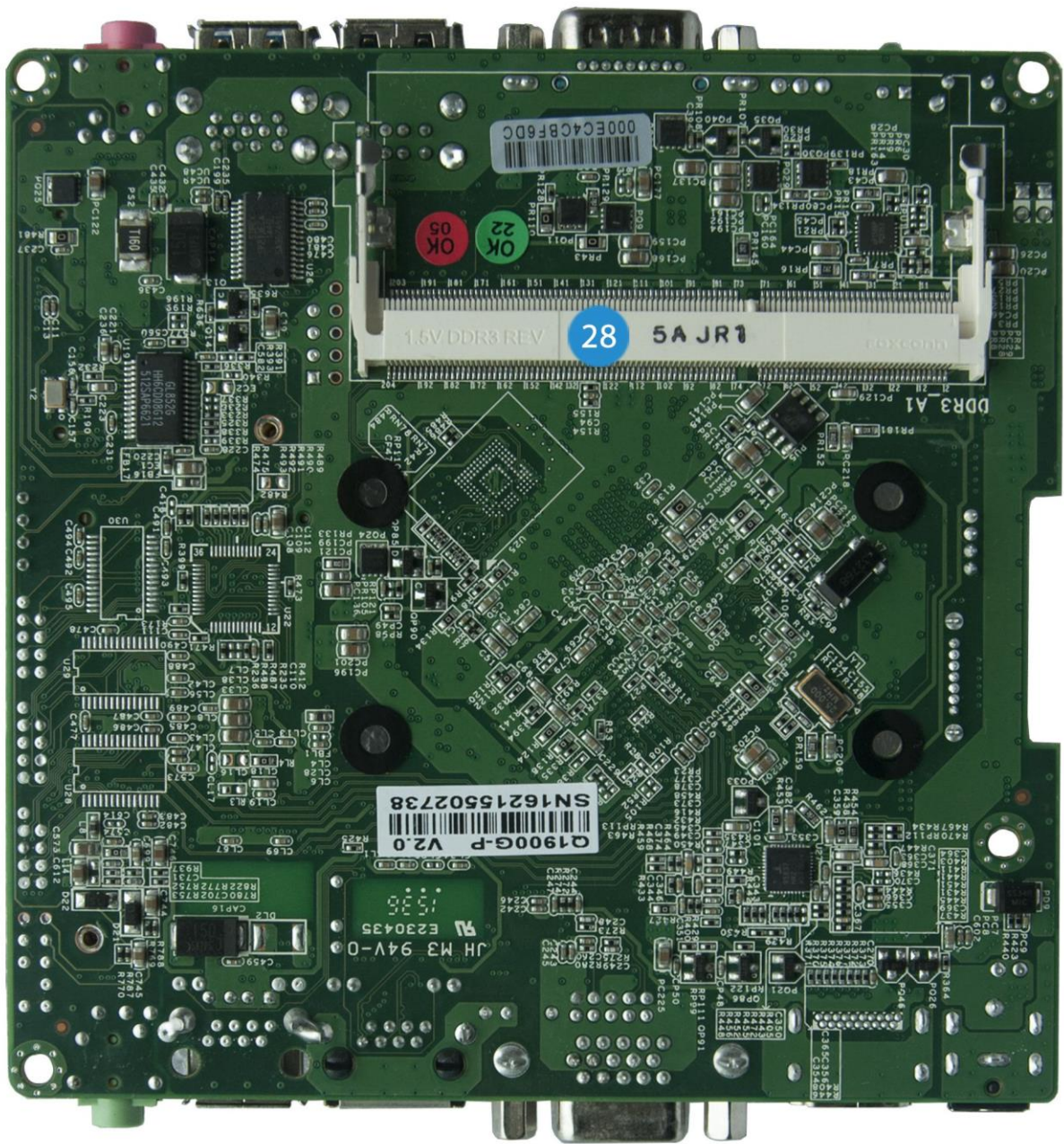

### 3. Connectors and Headers

Pin#	Description	Signal Name
1	12V-19V DC IN	PWR1
2	HDMI Connector	HDMI2
3	VGA Connector	VGA1
4	1000M LAN Port	LAN1
5	4 * USB 2.0 Ports	BACK_USB,UP_USB1,FRONT_USB1
6	Audio Output Port	F_OUT
7	SATA 3.0 Port (6.0 Gb/s)	SATA2
8	SATA Power Connector	PWR_SATA1
9	PCI Express Half-Mini Slot(For WIFI&Bluetooth)	MINIPCIE2
10	PCI Express Full-Mini Slot(For MSATA SSD)	MINIPCIE1
11	Intel Celeron J1800/J1900 Processor	U1
12	1 * USB 3.0 Port	UP_USB1
13	Serial Port	COM1
14	Power Switch	BUTTON1
15	Microphone Input	F_MIC
16	Extended Audio Input and Output Pin	F_AUDIO
20	Extended USB Pin	USB1
21	System Fan Header	CPU_FAN1
22	VGA Connection Pin	VGA2
23	Power Led	LED1

24	Extended Pin on External Panel	F_PANEL1
25	Debug Pin	JLPC1
26	DC IN header	PWR-IN1
27	Battery Slot	BAT1
28	Memory Slot	DDR3-A1

### **III、 Detailed Description of Connection Ports**

#### **1. Power Input Port**

Increased reliability with intensive electrical socket outlet.

12-19V power supply with wide voltage input, supporting 3A + current. Suitable for power adapter (Internal: the positive pole, external: the negative pole) which has the outside diameter of 5.5mm and inside diameter of 2.5mm.

#### **2. HDMI Connector**

Standard HDMI port

#### **3. VGA Connector**

Standard VGA port

#### **4. 1000M LAN Port**

Realtek RT8111E gigabit network, support diskless booting and Wake on LAN. ( Dual gigabit network )

#### **5. 4 \* USB 2.0 Ports**

Universal USB2.0 port.

#### **6. Audi Output Port**

Universal audio output port

#### **7. SATA 3.0 Port (6.0 Gb/s)**

Universal SATA3.0 port

**SATA Pinout - Plug**

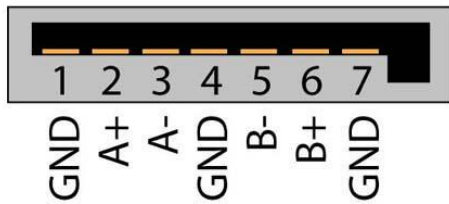

**8. SATA Power Connector**

Special power interface, please ask for matching wire from the distributor.

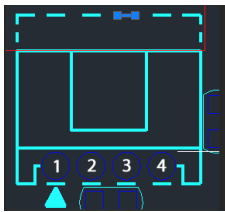

Pin#	1	2	3	4
Signal	Ground	Ground	+5V	+5V

Contact Spacing : 2.0mm

PS : Standard SATA Power Connector Definition

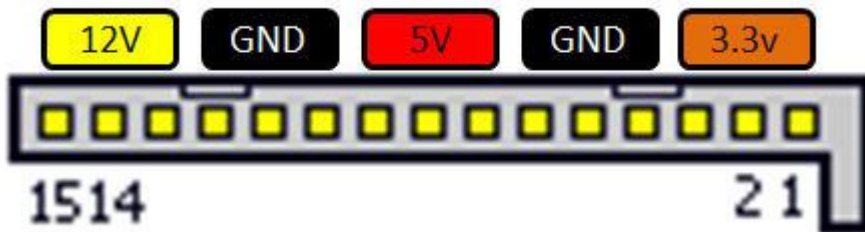

**9. PCI Express Half-Mini Card Slot (For WIFI and Bluetooth )**

Half Mini PCIE port for extending WIFI and Bluetooth

**10. PCI Express Full-Mini Card Slot (For MSATA SSD)**

Universal MINI SATA port for accessing MSATA SSD

**11. Intel Celeron J1800/J1900 Processor**

Model	CPU	# of Cores	Processor Base Frequency	Burst Frequency
Q1800N	J1800	2	2.41Ghz	2.58Ghz
Q1900N	J1900	4	2Ghz	2.42Ghz

**12. USB 3.0 Port**

USB3.0 port (5.0Gbps 640MB/s ) .

**13. Serial Port**

Standard RS232 port

Pin#	Signal	Define	Note
1	DCD	Data Carrier Detect	
2	RXD	Received Data	
3	TXD	Transmitted Data	
4	DTR	Data Terminal Ready	
5	GND	Signal Ground	
6	DSR	Data Send Ready	
7	RTS	Request to Send	
8	CTS	Clear to Send	
9	RI	Ring Indicator	

**14. Power Switch**

Power switch button

**15. Microphone Input**

Universal microphone input port

**16. Extended Audio Input and Output Pin**

For accessing extended audio input and output pin

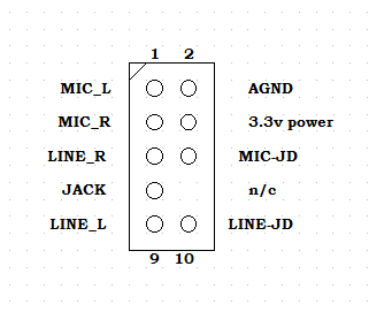

**17. Serial port headers (optional)**

COM2,



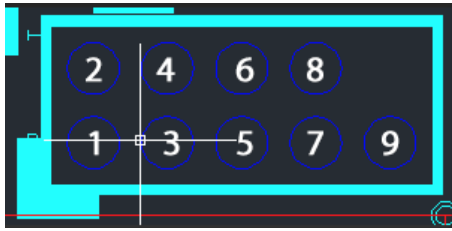

Pin#	Signal	Define	Note
1	DCD	Data Carrier Detect	
2	DSR	Data Send Ready	
3	RXD	Received Data	
4	RTS	Request to Send	
5	TXD	Transmitted Data	
6	CTS	Clear to Send	
7	DTR	Data Terminal Ready	
8	RI	Ring Indicator	
9	GND	Signal Ground	

**18. Serial port headers (optional)**

COM3, PIN definition refer to NO.17.

**19. Serial port headers (optional)**

COM4, PIN definition refer to NO.17.

**20. Extended USB Pin**

Pin for accessing extended USB2.0.



Pin#	Signal
1	+5V DC
2	D-
3	D+
4	Ground

**21. System Fan Header**

For connecting fan of the system

**22. VGA Connection Pin**

Pin for accessing extended VGA port, standard VGA Signal output



Pin#	Signal	Pin#	Signal
1	VCC_PWR	2	RED
3	DDC_DATA	4	GREEN
5	DDC_CLK	6	BLUE
7	VSYNC	8	GND
9	HSYNC	10	GND

**23. Power led**

Green color.

**24. Extended Pin for External Panel**

For accessing the power switch, power LED.

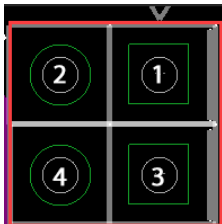

Function	Pin#	Signal	Function	Pin#	Signal
Power ON/OFF	1	GND	Power led	3	GND
	2	Power ON/OFF		4	Power led

**25. Debug Pin LPC1**

Pin for debugging and functional extension. The highlighted yellow one is the first pin.

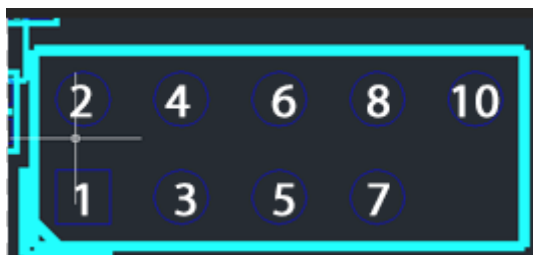

Pin#	Signal	Pin#	Signal
1	LPC_AD3	2	3.3V
3	LPC_AD2	4	BUF_PLT_RST

5	LPC_AD1	6	LPC_FRAME
7	LPC_AD0	8	CLK_DEBUG
		10	GND

**26. DC in header**

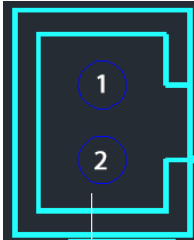

Pin#	Signal
1	+12V
2	GND

**27. Battery Slot**

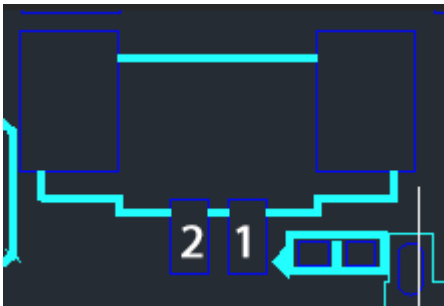

Pin#	Signal
1	+
2	-

**28. Memory Slot**

Only suitable for SO-DIMM of 1333 MHz or 1600 MHz (1.35V) working frequency, maximum 8 GB single-sided module.